

Capacitive evaluation unit - KFA Series *PER LEVEL*[®]

PNP output

- For capacitive filling level probes with 1 limit value switching point: KFS-5-1-...-15-Y95
- Operating voltage: 18...36 V DC
- With sensor break control
- With adjustable turn-off delay of 0...15 sec.

Certificate:



Technical data

Electrical version	4 wire DC
Output function	Antivalent
Type NPN	
Art. No	
Connection diagram No.	
Type PNP	KFA-5-1-L-P-A-FB-TD-Y90
Art. No.	AF 0082
Connection diagram No.	6
Operating voltage (U_B)	18...36 V DC
Output current max. (I_o)	2 x 250 mA
Voltage drop max. (U_d)	$\leq 2,5$ V
Permitted ripple max.	40 %
No-load current (I_o)	Typ. 50 mA
Switching frequency max.	4 Hz
Permitted ambient temperature	-25...+55 °C
LED display	Green/yellow
Protection circuit	Built-in
Degree of protection IEC 60529	IP 54
Norm	EN 60947-5-2
Connection cable	2 m, PVC, 4 x 0,34 mm ²
Housing material	PA

All specifications are subject to change without notice. (09.07.2008)

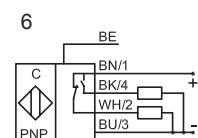
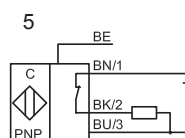
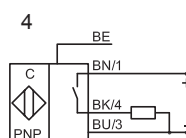
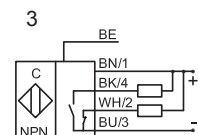
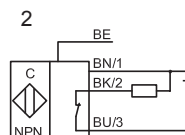
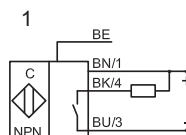
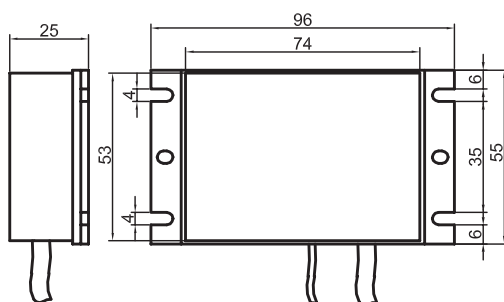

Made in Germany