



Capacitive filling level probe

Series ILevel - ATEX

Article number K10213

Description KFI-1-1000-950-VAc/PTFE/VAc-D13-TB50-G1-IL4-ETM-Y5-1G-1D

- For dry bulk materials and non-conductive liquids with low dielectric constant (e.g. oil)
- Analogue current output 4...20 mA
- For use in areas with the risk of dust explosion, zone 20
- For use in areas with the risk of gas explosion, zone 0
- ETM = Sensitivity adjustment is made by magnet on the teach spot.
- Area IBS PTFE-isolated
- With temperature barrier (TB50)

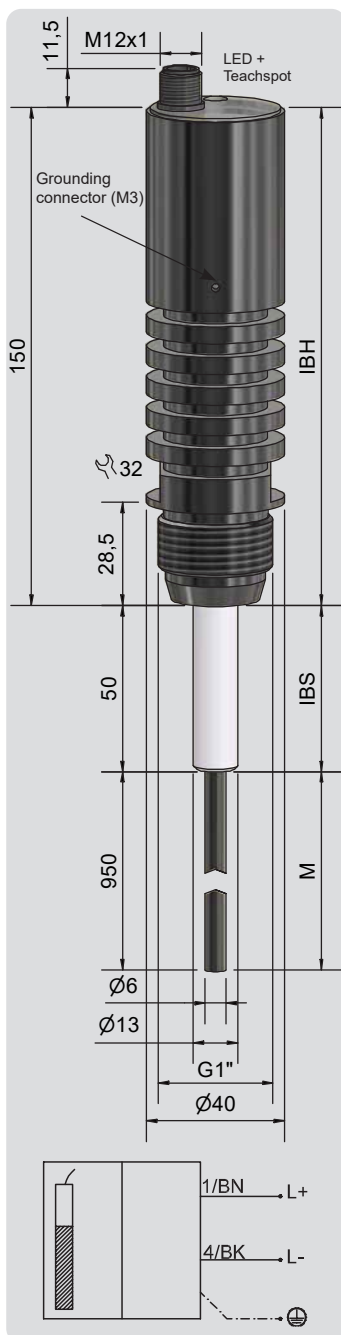

Technical data

Active zone [M]	950 mm
Probe length	1000 mm
Output function	Analogue
Sensitivity adjustment	ETM
Operating voltage (U _B)	15...30 V DC, U _i = 30 V DC
Current consumption min.	4 mA
Current consumption max.	20 mA
Permitted residual ripple max.	5 %
Load resistance (R _L)	≤ 200 Ω
Internal inductance (L)	0,2 mH
Internal capacitance (C)	0 nF (negligible)
Internal power (P _i)	1 W
Internal current (I _i)	100 mA
Permitted ambient temperature	-25...+70 °C
Permitted process temperature (measuring range)	-25...+250 °C
LED-Display	Green
Protective circuit	Built in
Degree of protection IEC 60529	IP66 / IP67
Connection	Flange connector M12 x 1 (A coded, 4 pole)
Norm	EN 60947-5-6, EN 60947-5-7*
Pressure	10 bar
Housing material / process adapter	Stainless steel No. 1.4404 - AISI 316 L
Measuring electrode	Stainless steel No. 1.4404 - AISI 316 L
Lid	PC (FDA 21 CFR 177.1580)
Housing material IBS	PTFE (FDA 21 CFR 177.1550)
Housing size	D13
Process connection / Thread	G 1"
Torque	180 Nm
ATEX certificate	CSANe 21ATEX2164X
ATEX product marking gas	Ex II 1 G Ex ia IIC T6...T1 Ga
ATEX product marking dust	Ex II 1 D Ex ia IIIC T135°C Da
IECEx certificate	IECEx CSA 21.0011X
IECEx product marking gas	Ex ia IIC T6...T1 Ga
IECEx product marking dust	Ex ia IIIC T135°C Da
Certificate(s)	UKCA CSAE 22UKEX1061X
MTTF (average operating time until failure in Years)	On demand
Accessories (included in delivery)	Protection clip, Teach magnet
Accessories Signal evaluator (not included in delivery)	Transmitter Power Supply #N00025
Matching connectors (not included in delivery)	Female connector, M12, DC, 2x0.34, 5 m, #193386
Made in Germany	
*where applicable	

All specifications are subject to change without notice. (05.12.2024)